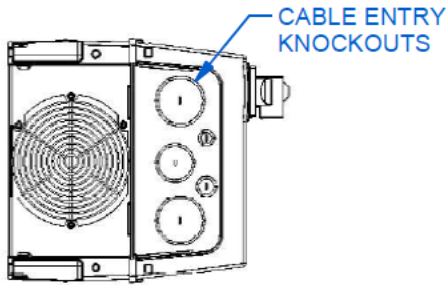
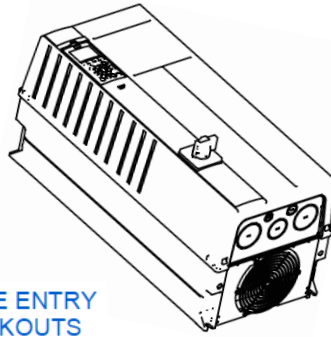
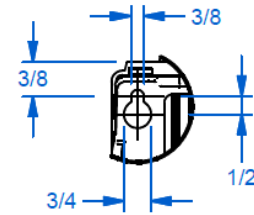
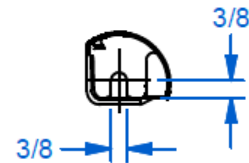
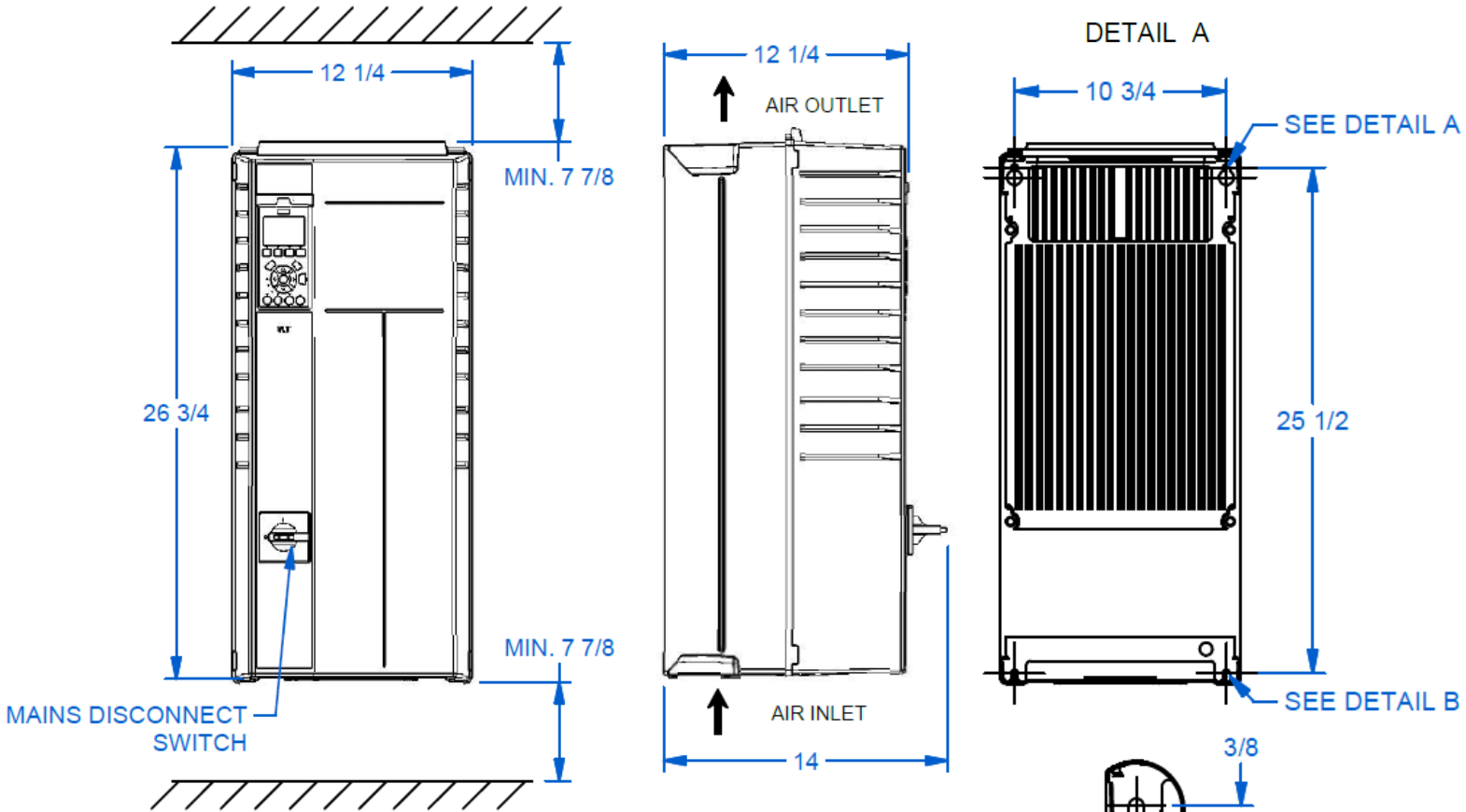

***Notes*:**

- Shielded cable required from VFD to motor
- All units are in inches otherwise specified

VFD Properties

Enclosure	IP66 [NEMA 4X]
Frame Size	C1
Rated	75 HP [45 - 55 Kw]
Supply Voltage [+/- 10%]	380 - 480V
Phase	3
Output Current 380-440V / 441-480V	90 / 80 A
Supply Frequency	106 / 105 Hz
Max Ambient Temperature	122 °F / 50 °C
Fused Disconnect	Yes
Weight	99 lbs

VFD Dimensions

DETAIL A

DETAIL B