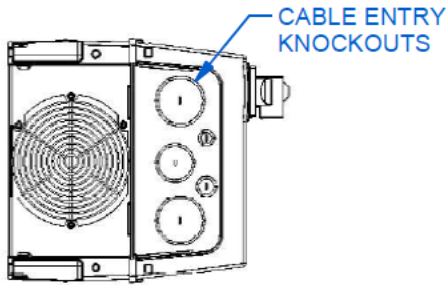
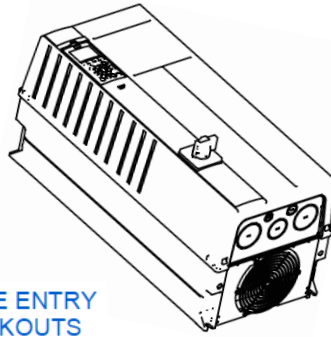
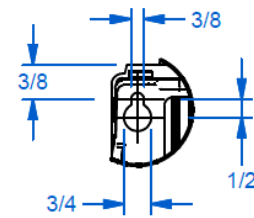
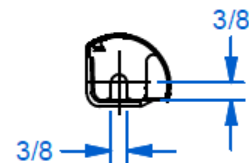
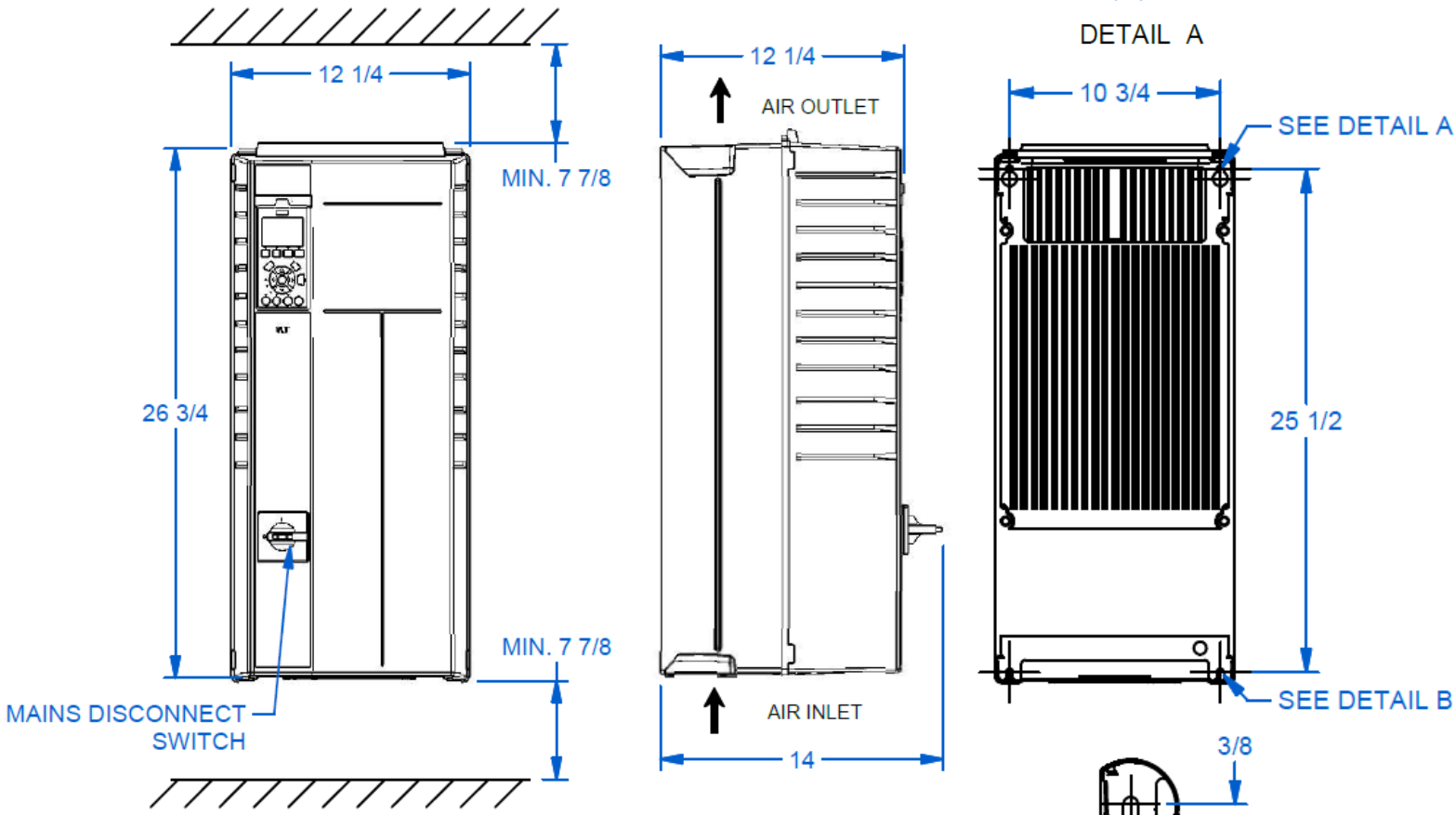

***Notes*:**

- Shielded cable required from VFD to motor
- All units are in inches otherwise specified

VFD Properties

Enclosure	IP66 [NEMA 4X]
Frame Size	C1
Rated	50 HP [30 - 37 Kw]
Supply Voltage [+/- 10%]	380 - 480V
Phase	3
Output Current 380-440V / 441-480V	73 / 65 A
Supply Frequency	50 / 60 Hz
Max Ambient Temperature	122 °F / 50 °C
Fused Disconnect	Yes
Weight	95 lbs

VFD Dimensions

DETAIL A

DETAIL B