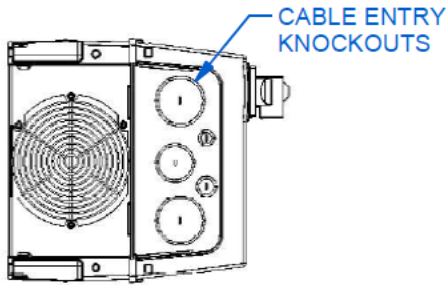
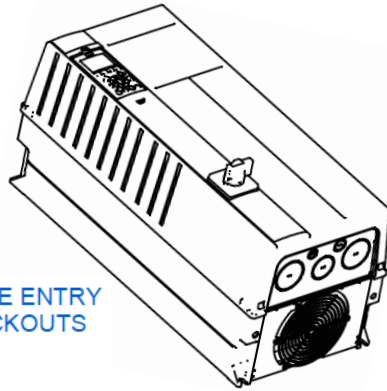
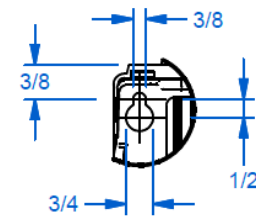
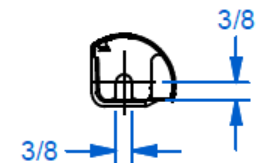
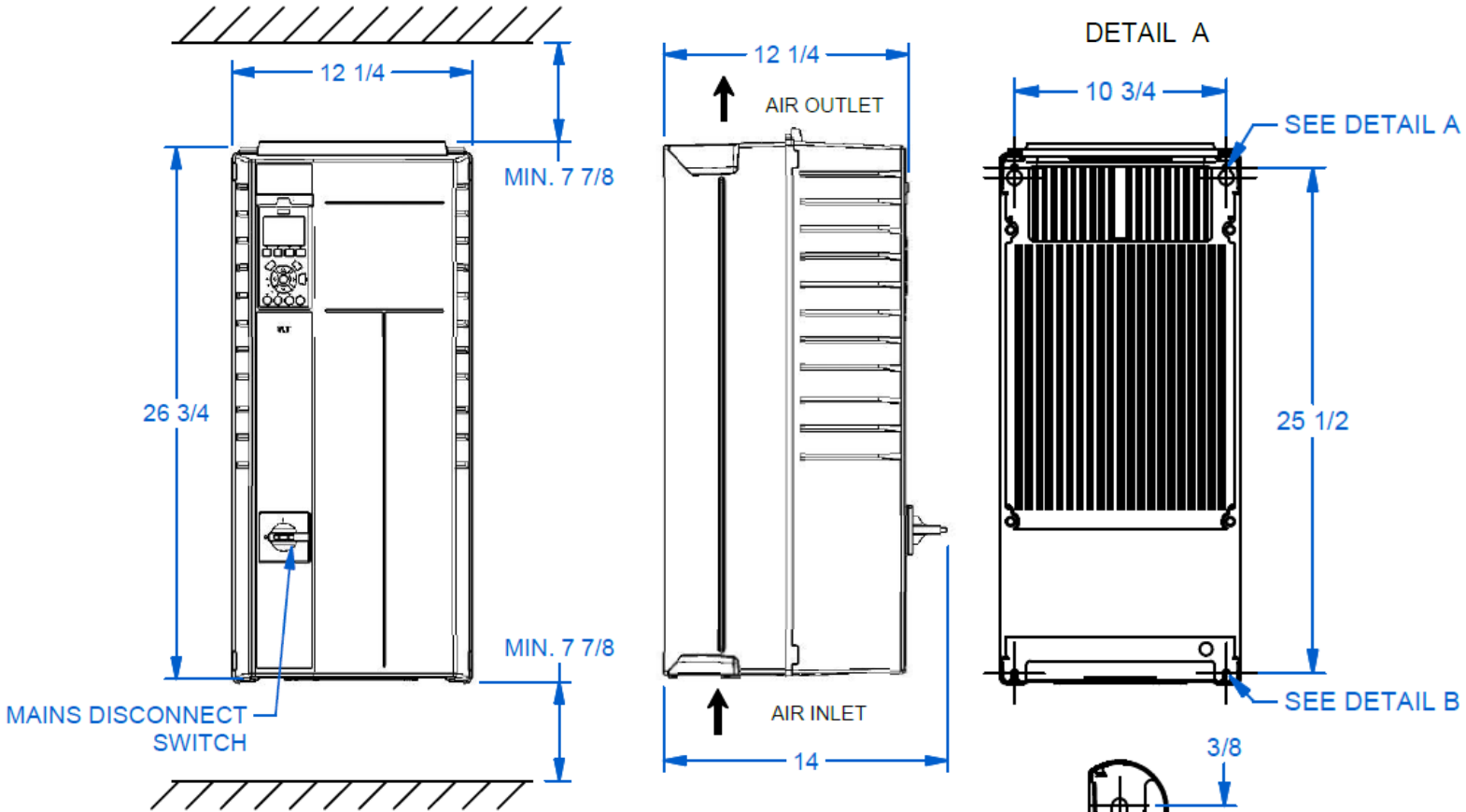

***Notes*:**

- Shielded cable required from VFD to motor
- All units are in inches otherwise specified

VFD Properties

Enclosure	IP66 [NEMA 4X]
Frame Size	C1
Rated	40 HP [22 - 30 Kw]
Supply Voltage [+/- 10%]	200 - 240V
Phase	3
Output Current 200 - 240V	115 A
Supply Frequency	50 / 60 Hz
Max Ambient Temperature	122 °F / 50 °C
Fused Disconnect	Yes
Weight	99 lbs

VFD Dimensions

DETAIL A

DETAIL B